

UF Core with Plastic Casing (UF Type)

1. Shape 形状

Fig 1

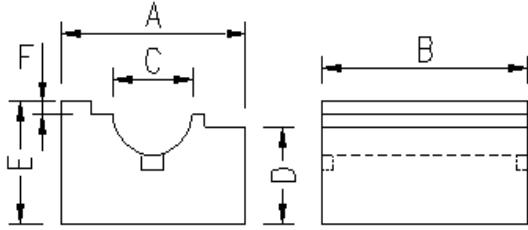

Fig 2

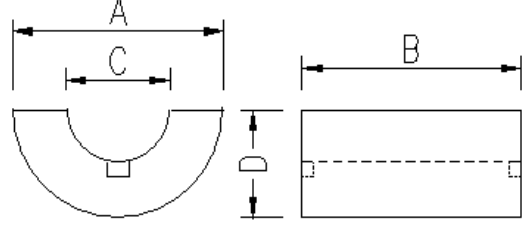

Fig 3

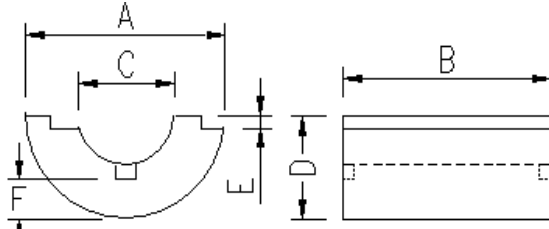

Fig 4

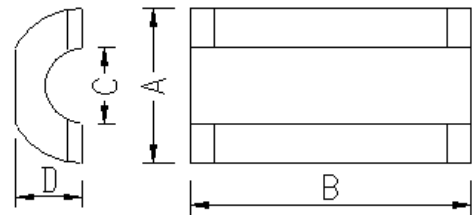

Fig 5

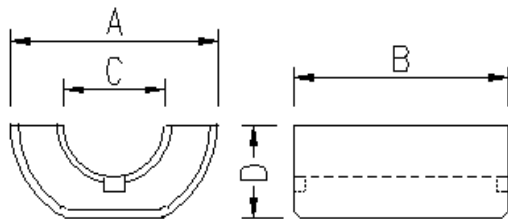

Fig 6

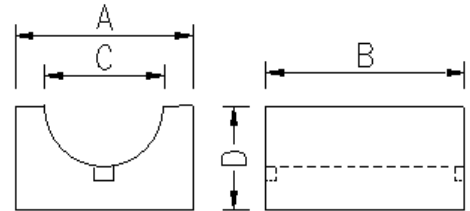

Fig 7

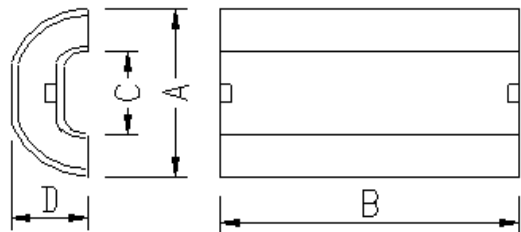

Fig 8

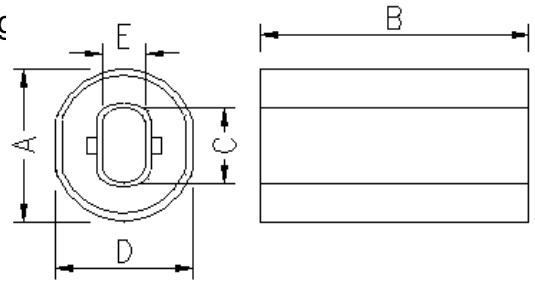

Fig 9

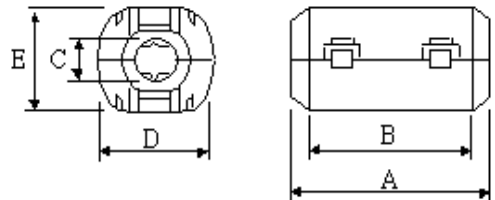

Fig 10

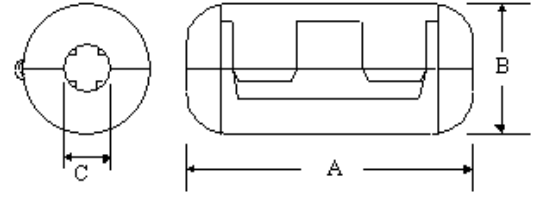

Fig 11

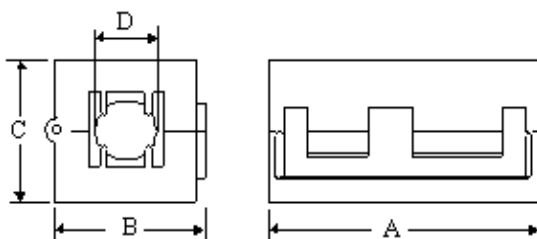
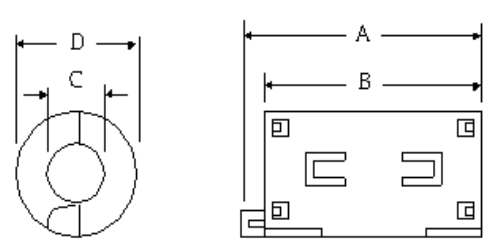
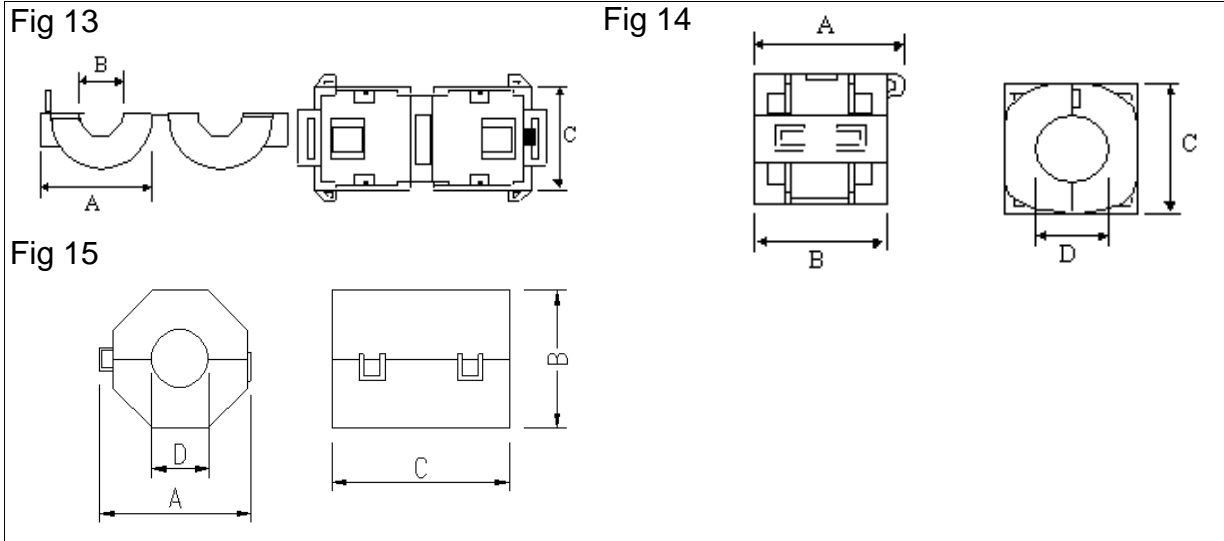

Fig 12



UF Core with Plastic Casing (UF Type)

1. Shape 形狀



2. Ordering Code 編碼規則

FZ1.5K UF 16 X 28 X 9 (LF-90)

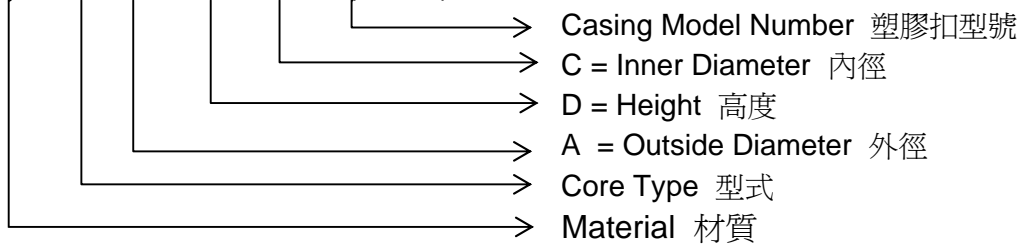

3. Dimensions 尺寸 (mm)

Core Size \ Conf.	A	B	C	D	E	F	Fig
UF 8.4x15.5x3.8	8.4±0.3	15.5±0.5	3.8±0.2	4.3±0.3			5
UF 8.4x15.5x3.8(LF-35)	25.0±0.7	14.5±0.4	3.8±0.2				10
UF 10.0x15.0x6.0	10.0±0.4	15.0±0.5	6.0±0.3	4.5±0.3			4
UF 10.0x15.0x6.0(S10)	15.5±0.5	14.0±0.4	18.5±0.5	4.5±0.3			15
UF 10.1X20.0X5.0	10.1±0.4	20.0±0.5	5.0±0.3	5.0±0.3			4
UF 10.1X20.0X5.0(0530A)	25.0±0.6	20.0±0.6	5.0±0.3	13.0±0.4	11.0±0.4		9
UF 10.1X20.0X5.3	10.1±0.4	20.0±0.6	5.3±0.3	5.1±0.3			5,6
UF 10.1X20.0X5.3(LF-50)	29.3±0.8	16.0±0.5	5.3±0.3				10
UF 10.1X20.0X5.3(LF-50S)	23.3±0.6	14.0±0.4	14.0±0.4	5.3±0.3			11
UF 12.0X15.0X7.0	12.0±0.4	15.0±0.5	7.0±0.3	5.5±0.3			4
UF 12.0X15.0X7.0(0730)	22.0±0.6	18.0±0.5	7.0±0.3	14.5±0.4			12
UF 13.0x23.0x5.2	13.0±0.4	23±0.6	5.2±0.3	6.3±0.3			4
UF 13.0x23.0x5.2(0730A)	30.0±0.8	23±0.6	5.2±0.3	17±1.0	15±0.5		9
UF 13.0X23.0X7.0	13.0±0.4	23.0±0.6	7.0±0.3	7.0±0.3			4
UF 13.0X23.0X7.0(0730A)	30.0±0.8	23.0±0.6	7.0±0.3	16.5±0.5	15.0±0.5		9
UF 15.0X29.5X6.5	15.0±0.5	29.5±0.8	6.5±0.3	7.65±0.3	9.5±0.3	2.0±0.2	1
UF 15.0X29.5X6.5	15.0±0.5	29.5±0.8	6.5±0.3	7.65±0.3			4
UF 15.0X29.5X6.5(LF-65S)	32.5±0.8	17.5±0.5	19.5±0.5	6.5±0.3			11

